

BİNGÖL İL ÖZEL İDARESİYOL ve ULAŞIM ŞUBE MÜDÜRLÜĞÜ
BİNGÖL İLİ ADAKLI İLÇESİ ELMAAĞAÇ KÖYÜ ÇAKMAK MEZRASI 1 ADET KÖPRÜ YAPIM İŞİ
3x7,5 (L=8 M) MENFEZ KROKİSİ

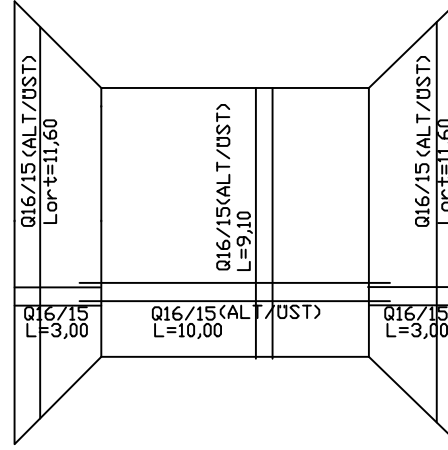

RADYE DONATI DETAYI

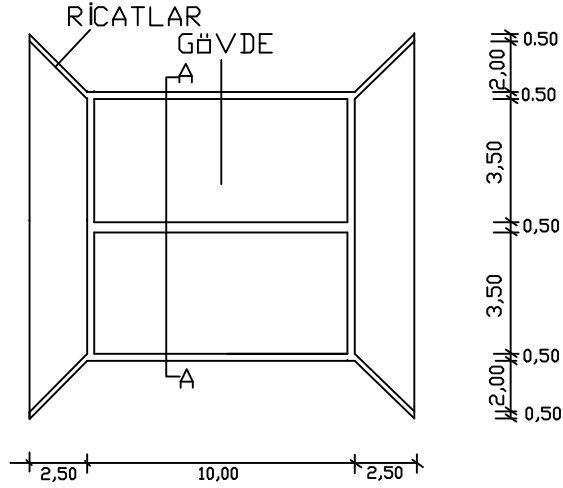
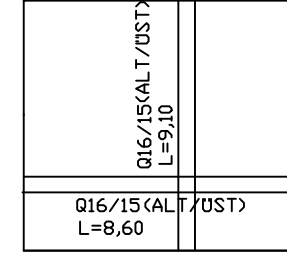

TABLİYE DONATI DETAYI

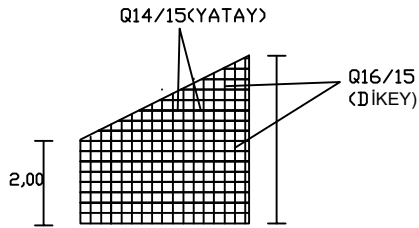
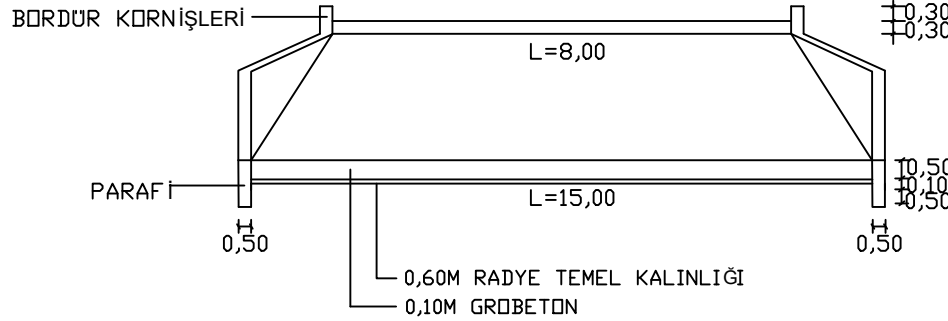

RİCAT DONATI DETAYI

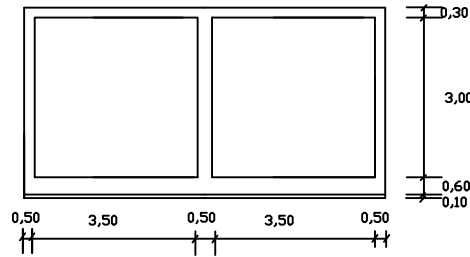

A-A KESİT DETAYI

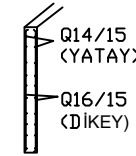

PERDE DONATI DETAYI

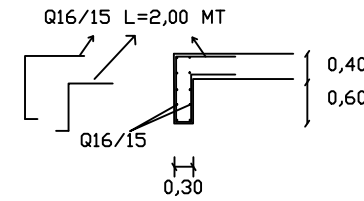

PARAFİ DONATI DETAYI

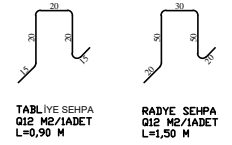

ÇİROZ Q10 M2/4ADET L=0,55 M

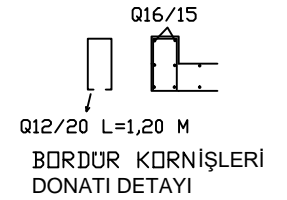

NOT: KULAK PERDE TEVZİ DONATILARI BİNDİRME BOYLARI EN AZ 1 METRE OLACAKTIR.